

IGBT - Power, Co-PAK, N-Channel, Field Stop VII (FS7), SCR, Power TO247-4L 1200 V, 1.45 V, 40 A AFGH4L40T120RWD

Description

Using the novel field stop 7th generation IGBT technology and the Gen7 Diode in TO247 4-lead package, this device offers the optimum performance with low on state voltage and minimal switching losses for both hard and soft switching topologies in automotive applications.

Features

- Extremely Efficient Trench with Field Stop Technology
- Maximum Junction Temperature – $T_J = 175^\circ\text{C}$
- Short Circuit Rated and Low Saturation Voltage
- Fast Switching and Tightened Parameter Distribution
- AEC-Q101 Qualified, PPAP Available Upon Request
- These Device is Pb-Free, Halogen Free/BFR Free and is RoHS Compliant

Applications

- Automotive E-compressor
- Automotive EV PTC Heater
- OBC

MAXIMUM RATINGS ($T_J = 25^\circ\text{C}$ unless otherwise noted)

Parameter	Symbol	Value	Unit	
Collector-to-Emitter Voltage	V_{CE}	1200	V	
Gate-to-Emitter Voltage	V_{GE}	± 20	V	
Transient Gate-to-Emitter Voltage		± 30		
Collector Current	I_C	$T_C = 25^\circ\text{C}$	80	A
		$T_C = 100^\circ\text{C}$	40	
Power Dissipation	P_D	$T_C = 25^\circ\text{C}$	576	W
		$T_C = 100^\circ\text{C}$	288	
Pulsed Collector Current	I_{CM}	120	A	
Diode Forward Current	I_F	$T_C = 25^\circ\text{C}$	80	A
		$T_C = 100^\circ\text{C}$	40	
Pulsed Diode Forward Current	I_{FM}	120	A	
Short Circuit Withstand Time $V_{GE} = 15\text{ V}, V_{CC} = 800\text{ V}, T_C = 150^\circ\text{C}$	T_{SC}	6	μs	
Operating Junction and Storage Temperature Range	T_J, T_{stg}	-55 to +175	$^\circ\text{C}$	
Lead Temperature for Soldering Purposes	T_L	260		

Stresses exceeding those listed in the Maximum Ratings table may damage the device. If any of these limits are exceeded, device functionality should not be assumed, damage may occur and reliability may be affected.

1. Repetitive rating: Pulse width limited by max. junction temperature

BV_{CES}	$V_{CE(sat)}$ TYP	I_C MAX
1200 V	1.45 V	40 A

PIN CONNECTIONS

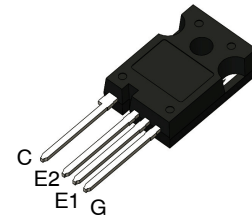
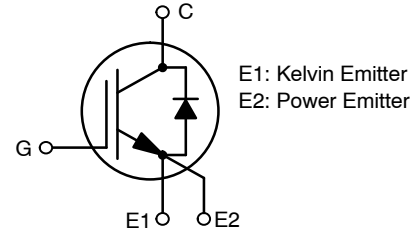

TO-247-4LD
CASE 340CJ

MARKING DIAGRAM

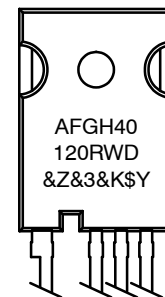

AFGH40120RWD = Specific Device Code
&Z = Assembly Plant Code
&3 = 3-Digit Date Code
&K = 2-Digit Lot Traceability Code
\$Y = onsemi Logo

ORDERING INFORMATION

Device	Package	Shipping
AFGH4L40T120RWD	TO-247-4L (Pb-Free)	30 Units / Rail

AFGH4L40T120RWD

THERMAL CHARACTERISTICS

Parameter	Symbol	Value	Unit
Thermal Resistance, Junction-to-Case for IGBT	$R_{\theta JC}$	0.26	°C/W
Thermal Resistance, Junction-to-Case for Diode	$R_{\theta JC}$	0.46	
Thermal Resistance, Junction-to-Ambient	$R_{\theta JA}$	40	

ELECTRICAL CHARACTERISTICS ($T_J = 25^\circ\text{C}$ unless otherwise specified)

Parameter	Symbol	Test Conditions	Min	Typ	Max	Unit
-----------	--------	-----------------	-----	-----	-----	------

OFF CHARACTERISTICS

Collector-to-Emitter Breakdown Voltage	BV_{CES}	$V_{GE} = 0\text{ V}, I_C = 1\text{ mA}$	1200	-	-	V
Collector-to-Emitter Breakdown Voltage Temperature Coefficient	$\Delta BV_{CES} / \Delta T_J$	$V_{GE} = 0\text{ V}, I_C = 9.99\text{ mA}$	-	1226	-	mV/°C
Zero Gate Voltage Collector Current	I_{CES}	$V_{GE} = 0\text{ V}, V_{CE} = V_{CES}$	-	-	40	μA
Gate-to-Emitter leakage Current	I_{GES}	$V_{GE} = \pm 20\text{ V}, V_{CE} = 0\text{ V}$	-	-	±400	nA

ON CHARACTERISTICS

Gate-to-Emitter Threshold Voltage	$V_{GE(th)}$	$V_{GE} = V_{CE}, I_C = 40\text{ mA}, T_J = 25^\circ\text{C}$	4.98	5.88	6.78	V
Collector-to-Emitter Saturation Voltage	$V_{CE(sat)}$	$V_{GE} = 15\text{ V}, I_C = 40\text{ A}, T_J = 25^\circ\text{C}$	-	1.45	1.78	V
		$V_{GE} = 15\text{ V}, I_C = 40\text{ A}, T_J = 175^\circ\text{C}$	-	1.75	-	

DYNAMIC CHARACTERISTICS

Input Capacitance	C_{IES}	$V_{CE} = 30\text{ V}, V_{GE} = 0\text{ V}, f = 1\text{ MHz}$	-	4713	-	pF
Output Capacitance	C_{OES}		-	195	-	pF
Reverse Transfer Capacitance	C_{RES}		-	23.8	-	pF
Total Gate Charge	Q_G	$V_{CE} = 600\text{ V}, V_{GE} = 15\text{ V}, I_C = 40\text{ A}$	-	171	-	nC
Gate-to-Emitter Charge	Q_{GE}		-	42.2	-	nC
Gate-to-Collector Charge	Q_{GC}		-	73.1	-	nC

SWITCHING CHARACTERISTICS

Turn-On Delay Time	$t_{d(on)}$	$V_{CE} = 600\text{ V}, V_{GE} = 0/15\text{ V}, I_C = 20\text{ A}, R_G = 6\ \Omega, T_J = 25^\circ\text{C}$	-	53.5	-	ns	
Turn-Off Delay Time	$t_{d(off)}$		-	311	-		
Rise Time	t_r		-	27.8	-		
Fall Time	t_f		-	189	-		
Turn-On Switching Loss	E_{on}	$V_{CE} = 600\text{ V}, V_{GE} = 0/15\text{ V}, I_C = 40\text{ A}, R_G = 6\ \Omega, T_J = 25^\circ\text{C}$	-	1.26	-	mJ	
Turn-Off Switching Loss	E_{off}		-	1.36	-		
Total Switching Loss	E_{ts}		-	2.61	-		
Turn-On Delay Time	$t_{d(on)}$		$V_{CE} = 600\text{ V}, V_{GE} = 0/15\text{ V}, I_C = 40\text{ A}, R_G = 6\ \Omega, T_J = 25^\circ\text{C}$	-	58.2	-	ns
Turn-Off Delay Time	$t_{d(off)}$			-	258	-	
Rise Time	t_r			-	47.4	-	
Fall Time	t_f			-	122	-	
Turn-On Switching Loss	E_{on}	-		3.38	-	mJ	
Turn-Off Switching Loss	E_{off}	-		1.7	-		
Total Switching Loss	E_{ts}	-		5.08	-		

AFGH4L40T120RWD

ELECTRICAL CHARACTERISTICS ($T_J = 25^\circ\text{C}$ unless otherwise specified) (continued)

Parameter	Symbol	Test Conditions	Min	Typ	Max	Unit
SWITCHING CHARACTERISTICS						
Turn-On Delay Time	$t_{d(on)}$	$V_{CE} = 600\text{ V}$ $V_{GE} = 0/15\text{ V}$ $I_C = 20\text{ A}$ $R_G = 6\ \Omega$ $T_J = 175^\circ\text{C}$	-	58.7	-	ns
Turn-Off Delay Time	$t_{d(off)}$		-	433	-	
Rise Time	t_r		-	39.4	-	
Fall Time	t_f		-	376	-	
Turn-On Switching Loss	E_{on}		-	2.01	-	mJ
Turn-Off Switching Loss	E_{off}		-	2.52	-	
Total Switching Loss	E_{ts}		-	4.53	-	
Turn-On Delay Time	$t_{d(on)}$	$V_{CE} = 600\text{ V}$ $V_{GE} = 0/15\text{ V}$ $I_C = 40\text{ A}$ $R_G = 6\ \Omega$ $T_J = 175^\circ\text{C}$	-	65.7	-	ns
Turn-Off Delay Time	$t_{d(off)}$		-	343	-	
Rise Time	t_r		-	64.7	-	
Fall Time	t_f		-	233	-	
Turn-On Switching Loss	E_{on}		-	5.45	-	mJ
Turn-Off Switching Loss	E_{off}		-	3.04	-	
Total Switching Loss	E_{ts}		-	8.49	-	

DIODE CHARACTERISTICS

Diode Forward Voltage	V_F	$I_F = 40\text{ A}, T_J = 25^\circ\text{C}$	-	1.55	1.85	V
		$I_F = 40\text{ A}, T_J = 175^\circ\text{C}$	-	1.54	-	

DIODE SWITCHING CHARACTERISTICS, INDUCTIVE LOAD

Reverse Recovery Time	t_{rr}	$V_R = 600\text{ V}, I_F = 20\text{ A},$ $di_F/dt = 500\text{ A}/\mu\text{s}$ $T_J = 25^\circ\text{C}$	-	145	-	ns
Reverse Recovery Charge	Q_{rr}		-	2055	-	nC
Reverse Recovery Energy	E_{rec}		-	0.49	-	mJ
Peak Reverse Recovery Current	I_{RRM}		-	34	-	A
Reverse Recovery Time	t_{rr}	$V_R = 600\text{ V}, I_F = 40\text{ A},$ $di_F/dt = 500\text{ A}/\mu\text{s}$ $T_J = 25^\circ\text{C}$	-	182	-	ns
Reverse Recovery Charge	Q_{rr}		-	3527	-	nC
Reverse Recovery Energy	E_{rec}		-	0.67	-	mJ
Peak Reverse Recovery Current	I_{RRM}		-	43.5	-	A
Reverse Recovery Time	t_{rr}	$V_R = 600\text{ V}, I_F = 20\text{ A},$ $di_F/dt = 500\text{ A}/\mu\text{s}$ $T_J = 175^\circ\text{C}$	-	204	-	ns
Reverse Recovery Charge	Q_{rr}		-	3606	-	nC
Reverse Recovery Energy	E_{rec}		-	1.07	-	mJ
Peak Reverse Recovery Current	I_{RRM}		-	42.3	-	A
Reverse Recovery Time	t_{rr}	$V_R = 600\text{ V}, I_F = 40\text{ A},$ $di_F/dt = 500\text{ A}/\mu\text{s}$ $T_J = 175^\circ\text{C}$	-	253	-	ns
Reverse Recovery Charge	Q_{rr}		-	6542	-	nC
Reverse Recovery Energy	E_{rec}		-	1.52	-	mJ
Peak Reverse Recovery Current	I_{RRM}		-	57.6	-	A

Product parametric performance is indicated in the Electrical Characteristics for the listed test conditions, unless otherwise noted. Product performance may not be indicated by the Electrical Characteristics if operated under different conditions.

AFGH4L40T120RWD

TYPICAL CHARACTERISTICS

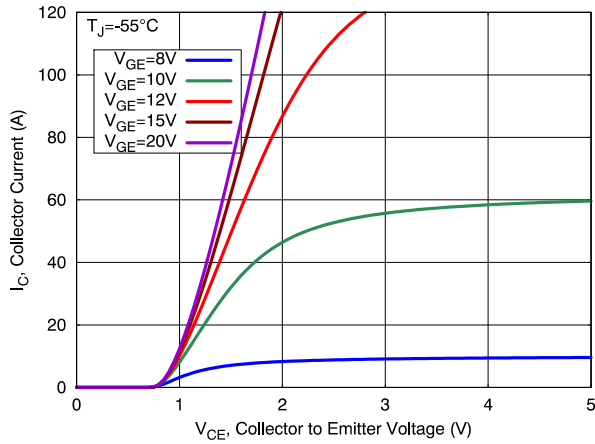

Figure 1. Output Characteristics

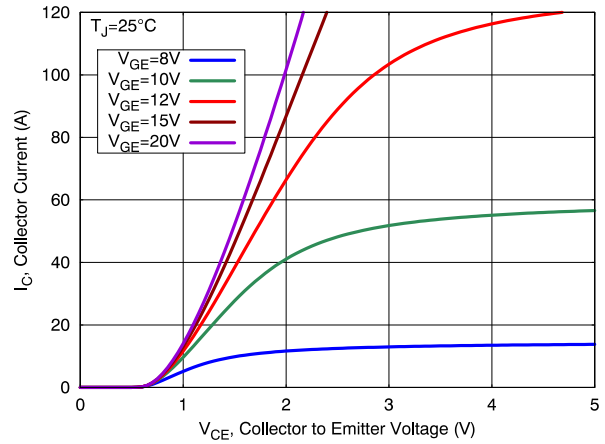

Figure 2. Output Characteristics

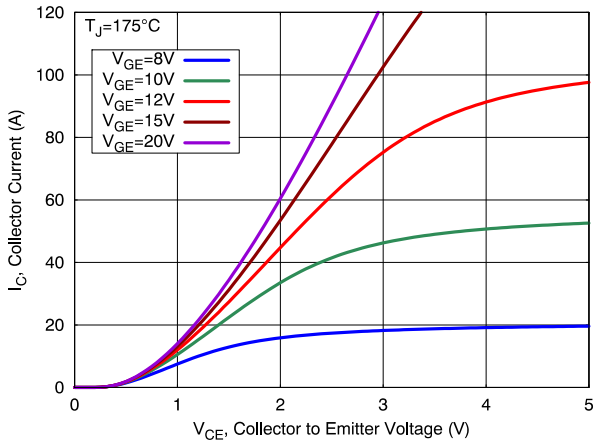

Figure 3. Output Characteristics

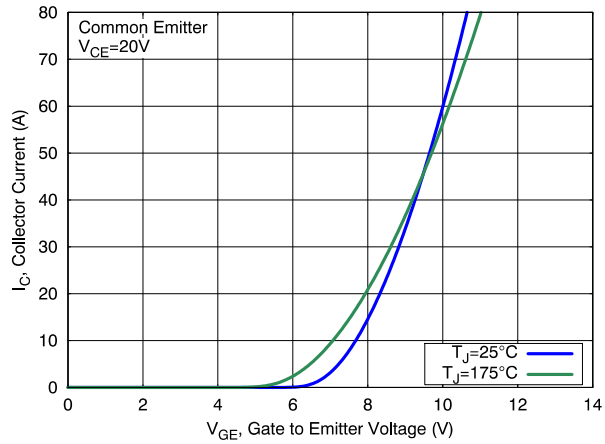

Figure 4. Transfer Characteristics

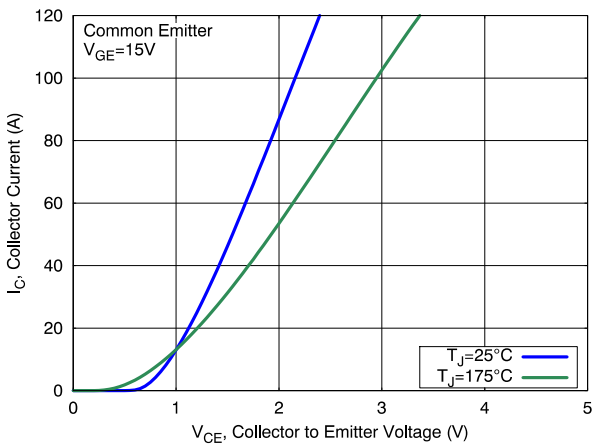

Figure 5. Saturation Characteristics

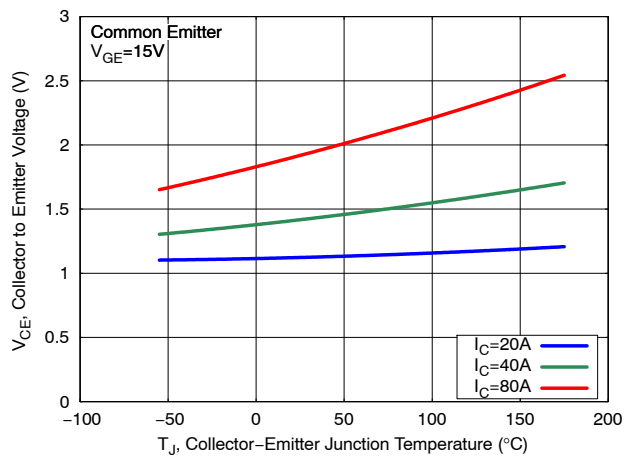

Figure 6. Saturation Voltage vs. Junction Temperature

AFGH4L40T120RWD

TYPICAL CHARACTERISTICS

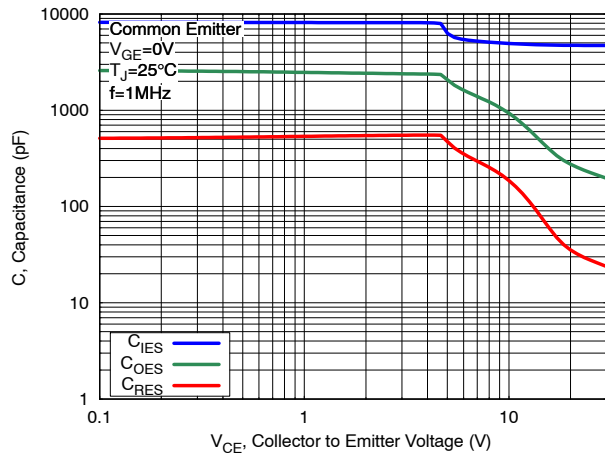

Figure 7. Capacitance Characteristics

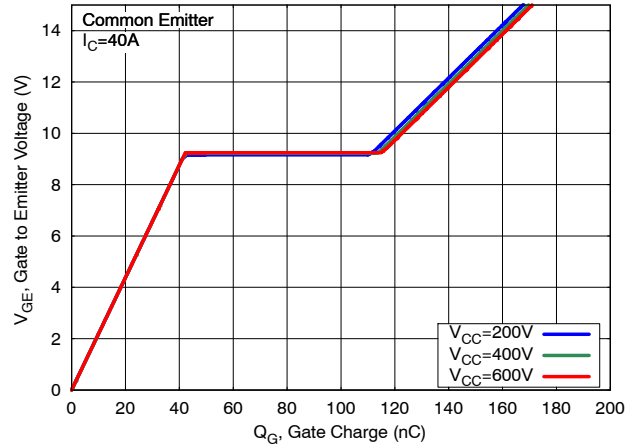

Figure 8. Gate Charge Characteristics

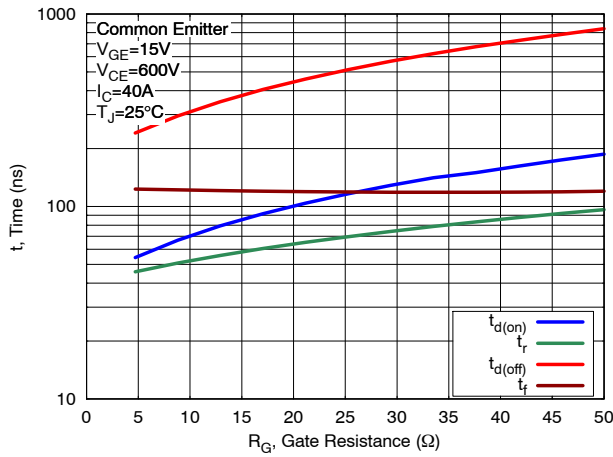

Figure 9. Switching Time vs Gate Resistance

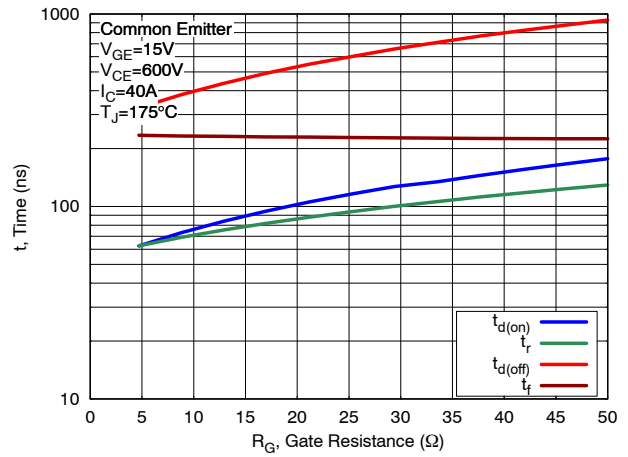

Figure 10. Switching Time vs Gate Resistance

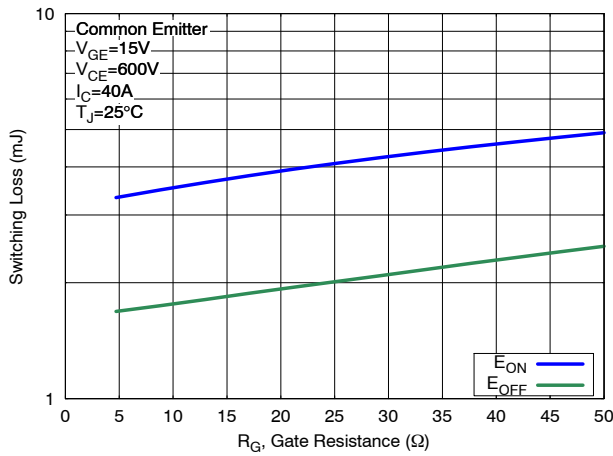

Figure 11. Switching Loss vs Gate Resistance

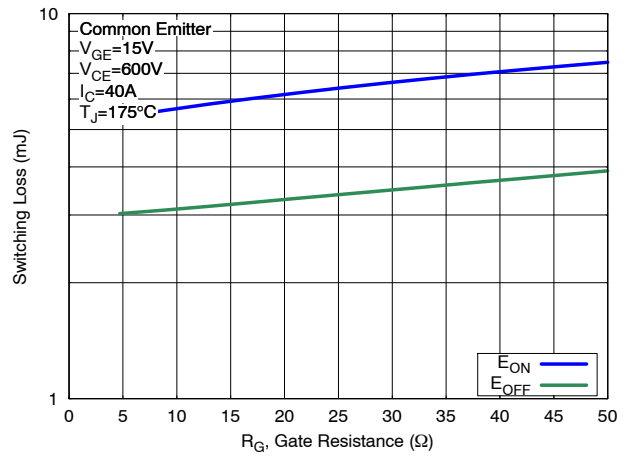

Figure 12. Switching Loss vs Gate Resistance

AFGH4L40T120RWD

TYPICAL CHARACTERISTICS

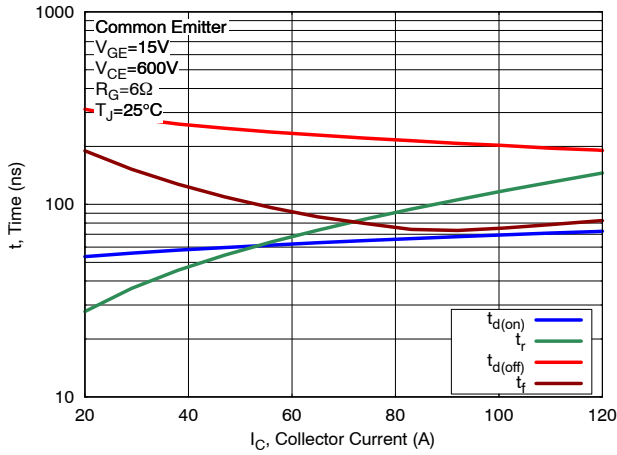

Figure 13. Switching Time vs Collector Current

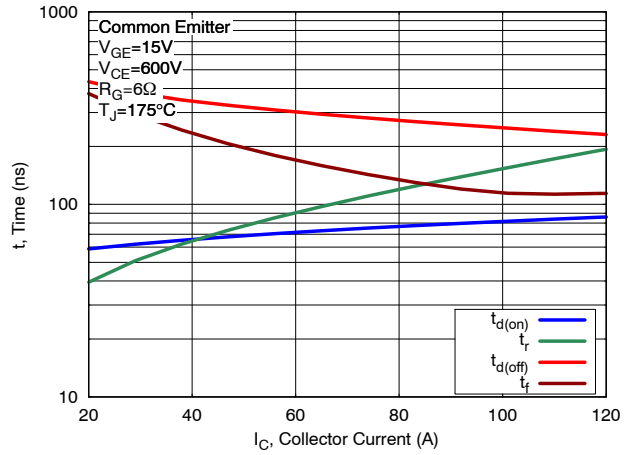

Figure 14. Switching Time vs Collector Current

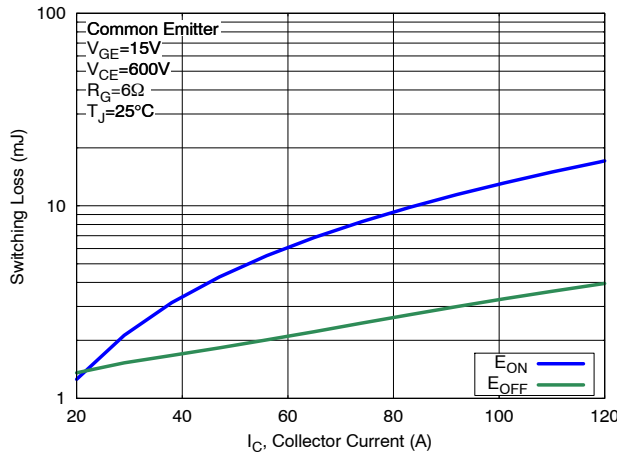

Figure 15. Switching Loss vs Collector Current

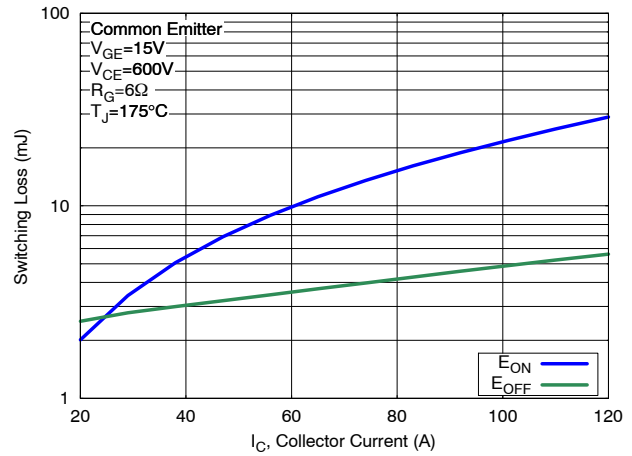

Figure 16. Switching Loss vs Collector Current

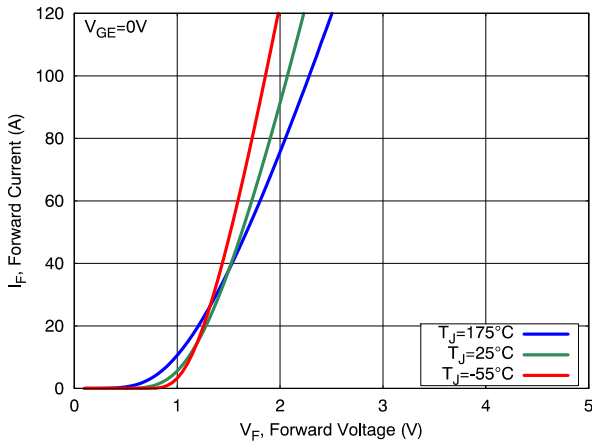

Figure 17. Diode Forward Characteristics

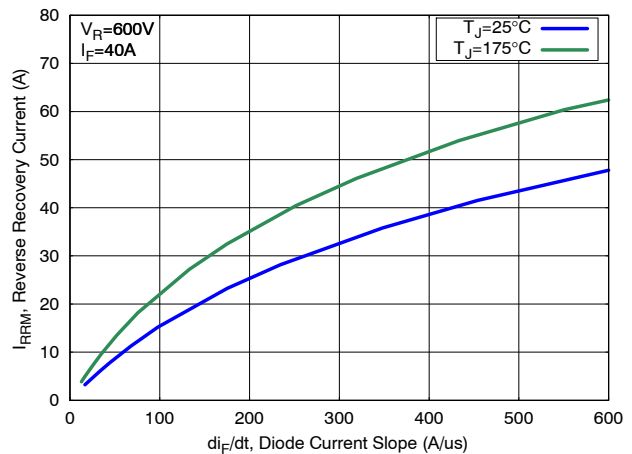

Figure 18. Diode Reverse Recovery Current

AFGH4L40T120RWD

TYPICAL CHARACTERISTICS

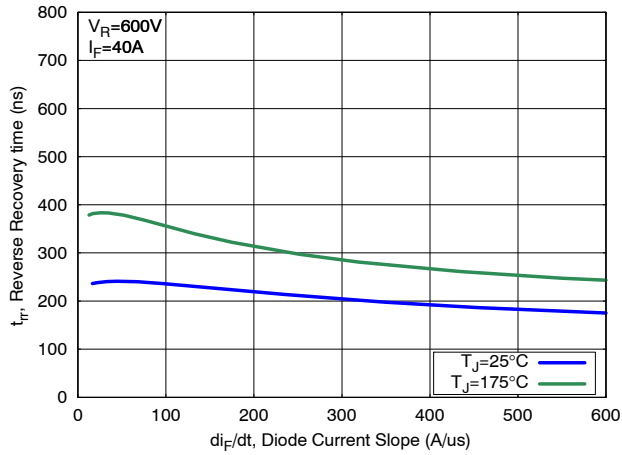

Figure 19. Diode Reverse Recovery Time

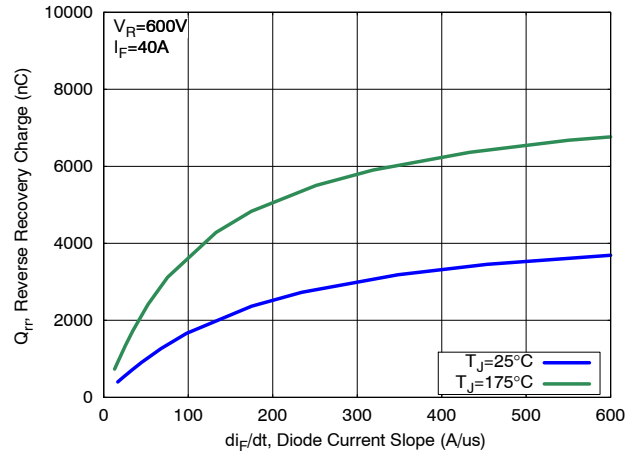

Figure 20. Diode Stored Charge Characteristics

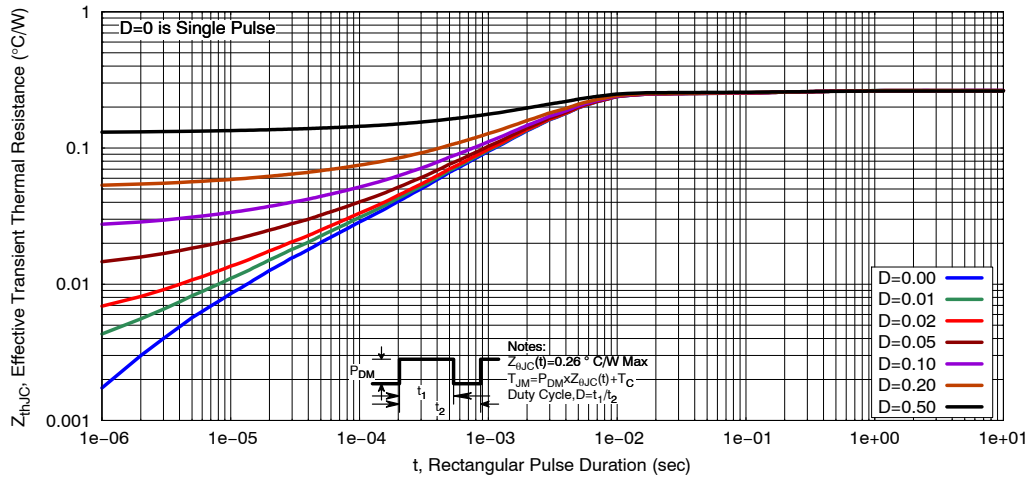

Figure 21. Transient Thermal Impedance of IGBT

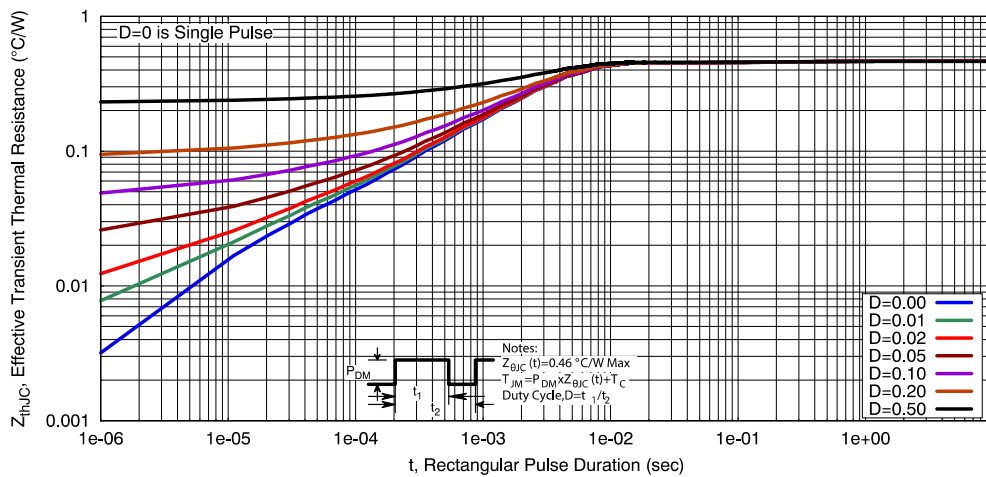
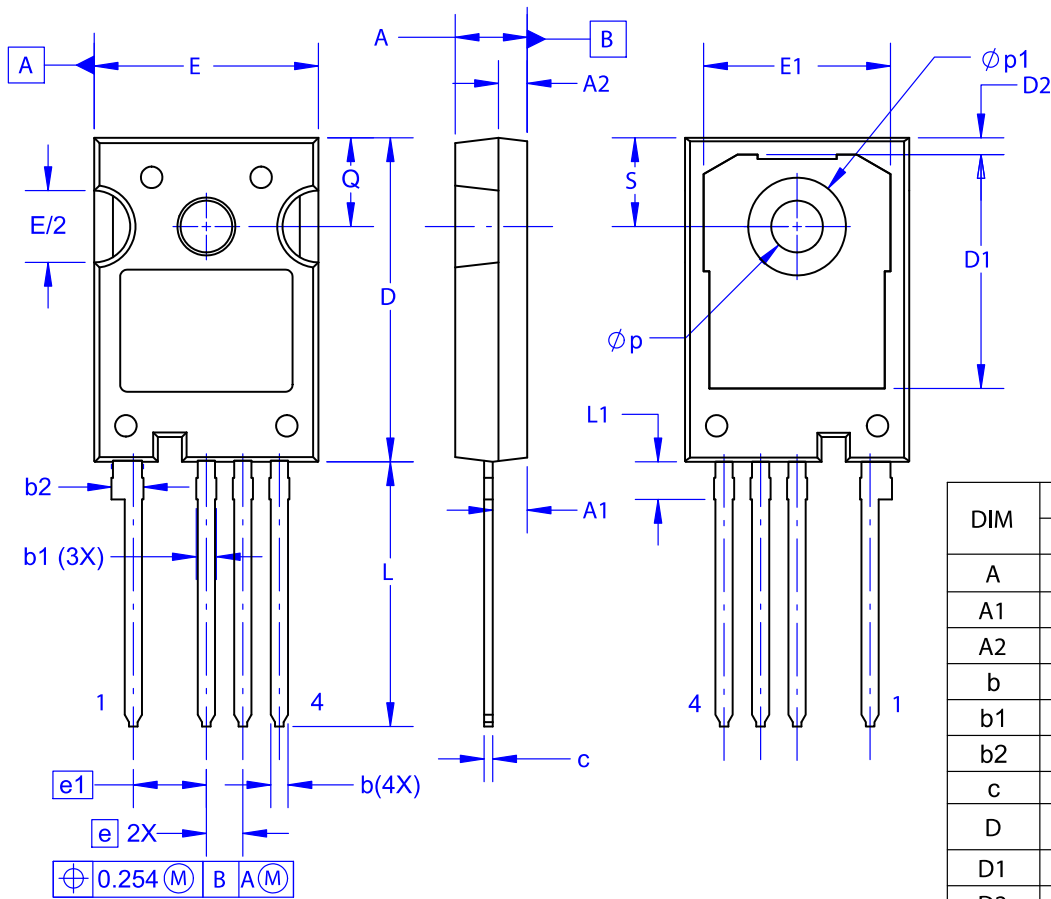

Figure 22. Transient Thermal Impedance of Diode

TO-247-4LD
CASE 340CJ
ISSUE A

DATE 16 SEP 2019



NOTES:

- A. NO INDUSTRY STANDARD APPLIES TO THIS PACKAGE.
- B. DIMENSIONS ARE EXCLUSIVE OF BURRS, MOLD FLASH, AND TIE BAR EXTRUSIONS.
- C. ALL DIMENSIONS ARE IN MILLIMETERS.
- D. DRAWING CONFORMS TO ASME Y14.5-2009.

DIM	MILLIMETERS		
	MIN	NOM	MAX
A	4.80	5.00	5.20
A1	2.10	2.40	2.70
A2	1.80	2.00	2.20
b	1.07	1.20	1.33
b1	1.20	1.40	1.60
b2	2.02	2.22	2.42
c	0.50	0.60	0.70
D	22.34	22.54	22.74
D1	16.00	16.25	16.50
D2	0.97	1.17	1.37
e	2.54 BSC		
e1	5.08 BSC		
E	15.40	15.60	15.80
E1	12.80	13.00	13.20
E/2	4.80	5.00	5.20
L	18.22	18.42	18.62
L1	2.42	2.62	2.82
p	3.40	3.60	3.80
p1	6.60	6.80	7.00
Q	5.97	6.17	6.37
S	5.97	6.17	6.37

DOCUMENT NUMBER:	98AON13852G	Electronic versions are uncontrolled except when accessed directly from the Document Repository. Printed versions are uncontrolled except when stamped "CONTROLLED COPY" in red.
DESCRIPTION:	TO-247-4LD	PAGE 1 OF 1

onsemi and Onsemi are trademarks of Semiconductor Components Industries, LLC dba onsemi or its subsidiaries in the United States and/or other countries. onsemi reserves the right to make changes without further notice to any products herein. onsemi makes no warranty, representation or guarantee regarding the suitability of its products for any particular purpose, nor does onsemi assume any liability arising out of the application or use of any product or circuit, and specifically disclaims any and all liability, including without limitation special, consequential or incidental damages. onsemi does not convey any license under its patent rights nor the rights of others.

onsemi, **Onsemi**, and other names, marks, and brands are registered and/or common law trademarks of Semiconductor Components Industries, LLC dba "**onsemi**" or its affiliates and/or subsidiaries in the United States and/or other countries. **onsemi** owns the rights to a number of patents, trademarks, copyrights, trade secrets, and other intellectual property. A listing of **onsemi**'s product/patent coverage may be accessed at www.onsemi.com/site/pdf/Patent-Marking.pdf. **onsemi** reserves the right to make changes at any time to any products or information herein, without notice. The information herein is provided "as-is" and **onsemi** makes no warranty, representation or guarantee regarding the accuracy of the information, product features, availability, functionality, or suitability of its products for any particular purpose, nor does **onsemi** assume any liability arising out of the application or use of any product or circuit, and specifically disclaims any and all liability, including without limitation special, consequential or incidental damages. Buyer is responsible for its products and applications using **onsemi** products, including compliance with all laws, regulations and safety requirements or standards, regardless of any support or applications information provided by **onsemi**. "Typical" parameters which may be provided in **onsemi** data sheets and/or specifications can and do vary in different applications and actual performance may vary over time. All operating parameters, including "Typicals" must be validated for each customer application by customer's technical experts. **onsemi** does not convey any license under any of its intellectual property rights nor the rights of others. **onsemi** products are not designed, intended, or authorized for use as a critical component in life support systems or any FDA Class 3 medical devices or medical devices with a same or similar classification in a foreign jurisdiction or any devices intended for implantation in the human body. Should Buyer purchase or use **onsemi** products for any such unintended or unauthorized application, Buyer shall indemnify and hold **onsemi** and its officers, employees, subsidiaries, affiliates, and distributors harmless against all claims, costs, damages, and expenses, and reasonable attorney fees arising out of, directly or indirectly, any claim of personal injury or death associated with such unintended or unauthorized use, even if such claim alleges that **onsemi** was negligent regarding the design or manufacture of the part. **onsemi** is an Equal Opportunity/Affirmative Action Employer. This literature is subject to all applicable copyright laws and is not for resale in any manner.

ADDITIONAL INFORMATION

TECHNICAL PUBLICATIONS:

Technical Library: www.onsemi.com/design/resources/technical-documentation
onsemi Website: www.onsemi.com

ONLINE SUPPORT: www.onsemi.com/support

For additional information, please contact your local Sales Representative at www.onsemi.com/support/sales