

# IGBT for Automotive Application

## 650 V, 30 A

### AFGHL30T65RQDN

Using novel field stop IGBT technology, **onsemi**'s new series of FS4 IGBTs offer the optimum performance for automotive applications. This technology is Short circuit rated and offers high figure of merit with low conduction and switching losses.

#### Features

- Maximum Junction Temperature:  $T_J = 175^\circ\text{C}$
- Positive Temperature Co-efficient for Easy Parallel Operation
- High Current Capability
- Low Saturation Voltage:  $V_{CE(Sat)} = 1.57\text{ V (Typ.) @ } I_C = 30\text{ A}$
- 100% of the Parts Tested for  $I_{LM}$  (Note 2)
- High Input Impedance
- Fast Switching
- Tightened Parameter Distribution
- This Device is Pb-Free and RoHS Compliant

#### Typical Applications

- E-compressor for HEV/EV, PTC heater for HEV/EV

#### MAXIMUM RATINGS

Rating	Symbol	Value	Unit
Collector-to-Emitter Voltage	$V_{CES}$	650	V
Gate-to-Emitter Voltage Transient Gate-to-Emitter Voltage	$V_{GES}$	$\pm 20$ $\pm 30$	V
Collector Current (Note 1) @ $T_C = 25^\circ\text{C}$ @ $T_C = 100^\circ\text{C}$	$I_C$	42 30	A
Pulsed Collector Current (Note 2)	$I_{LM}$	120	A
Pulsed Collector Current (Note 3)	$I_{CM}$	120	A
Diode Forward Current (Note 1) @ $T_C = 25^\circ\text{C}$ @ $T_C = 100^\circ\text{C}$	$I_F$	42 30	A
Pulsed Diode Maximum Forward Current	$I_{FM}$	120	A
Non-Repetitive Forward Surge Current (Half-Sine Pulse, $t_p = 8.3\text{ ms}$ , $T_C = 25^\circ\text{C}$ ) (Half-Sine Pulse, $t_p = 8.3\text{ ms}$ , $T_C = 150^\circ\text{C}$ )	$I_{FM}$	140 100	A
Short Circuit Withstand Time $V_{GE} = 15\text{ V}$ , $V_{CC} = 400\text{ V}$ , $T_C = 150^\circ\text{C}$	$t_{SC}$	5	$\mu\text{s}$
Maximum Power Dissipation @ $T_C = 25^\circ\text{C}$ @ $T_C = 100^\circ\text{C}$	$P_D$	230.8 115.4	W
Operating Junction/Storage Temperature Range	$T_J, T_{STG}$	-55 to +175	$^\circ\text{C}$
Maximum Lead Temp. for Soldering Purposes, 1/8" from case for 5 seconds	$T_L$	265	$^\circ\text{C}$

Stresses exceeding those listed in the Maximum Ratings table may damage the device. If any of these limits are exceeded, device functionality should not be assumed, damage may occur and reliability may be affected.

1. Value limited by bond wire.
2.  $V_{CC} = 600\text{ V}$ ,  $V_{GE} = 15\text{ V}$ ,  $I_C = 90\text{ A}$ ,  $R_G = 75\ \Omega$ , Inductive Load, 100% Tested.
3. Repetitive Rating: pulse width limited by max. Junction temperature.

**30 A, 650 V,**  
 $V_{CE(Sat)} = 1.57\text{ V (Typ.)}$

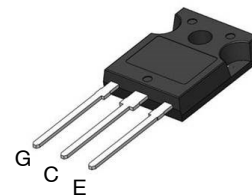
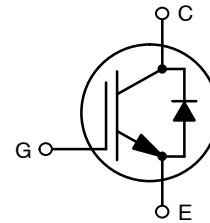

**TO-247-3L  
CASE 340CX**

#### MARKING DIAGRAM



A = Assembly Site  
 WW = Work Week Number  
 Y = Year of Production, Last Number  
 ZZ = Assembly Lot Number  
 AFGHL30T65RQDN = Specific Device Code

#### ORDERING INFORMATION

Device	Package	Shipping
AFGHL30T65RQDN	TO-247-3L (Pb-Free)	30 Units / Rail

# AFGHL30T65RQDN

## THERMAL CHARACTERISTICS

Rating	Symbol	Min	Typ	Max	Unit
Thermal Resistance Junction-to-Case, for IGBT	$R_{\theta JC}$	-	0.50	0.65	°C/W
Thermal Resistance Junction-to-Case, for Diode	$R_{\theta JC}$	-	0.92	1.19	
Thermal Resistance Junction-to-Ambient	$R_{\theta JA}$	-	-	40	

## ELECTRICAL CHARACTERISTICS ( $T_J = 25^\circ\text{C}$ unless otherwise noted)

Parameter	Test Conditions	Symbol	Min	Typ	Max	Unit
-----------	-----------------	--------	-----	-----	-----	------

### OFF CHARACTERISTICS

Collector-emitter Breakdown Voltage, Gate-emitter Short-circuited	$V_{GE} = 0\text{ V}, I_C = 1\text{ mA}$	$BV_{CES}$	650	-	-	V
Temperature Coefficient of Breakdown Voltage	$V_{GE} = 0\text{ V}, I_C = 1\text{ mA}$	$\frac{\Delta BV_{CES}}{\Delta T_J}$	-	0.58	-	V/°C
Collector-emitter Cut-off Current, Gate-emitter Short-circuited	$V_{GE} = 0\text{ V}, V_{CE} = V_{CES}$	$I_{CES}$	-	-	30	μA
Gate Leakage Current, Collector-emitter Short-circuited	$V_{GE} = V_{GES}, V_{CE} = 0\text{ V}$	$I_{GES}$	-	-	±400	nA

### ON CHARACTERISTICS

Gate-emitter Threshold Voltage	$V_{GE} = V_{CE}, I_C = 30\text{ mA}$	$V_{GE(th)}$	4.30	5.30	6.30	V
Collector-emitter Saturation Voltage	$V_{GE} = 15\text{ V}, I_C = 30\text{ A}, T_J = 25^\circ\text{C}$ $V_{GE} = 15\text{ V}, I_C = 30\text{ A}, T_J = 175^\circ\text{C}$	$V_{CE(sat)}$	-	1.57 1.88	1.82 -	V

### DYNAMIC CHARACTERISTICS

Input Capacitance	$V_{CE} = 30\text{ V}, V_{GE} = 0\text{ V}, f = 1\text{ MHz}$	$C_{ies}$	-	1570	-	pF
Output Capacitance		$C_{oes}$	-	56	-	
Reverse Transfer Capacitance		$C_{res}$	-	7	-	
Gate Resistance	$f = 1\text{ MHz}$	$R_g$	-	15	-	Ω
Gate Charge Total	$V_{CC} = 400\text{ V}, I_C = 30\text{ A}, V_{GE} = 15\text{ V}$	$Q_g$	-	37	-	nC
Gate-Emitter Charge		$Q_{ge}$	-	11	-	
Gate-Collector Charge		$Q_{gc}$	-	10	-	

### SWITCHING CHARACTERISTICS, INDUCTIVE LOAD

Turn-on Delay Time	$T_J = 25^\circ\text{C}, V_{CC} = 400\text{ V}, I_C = 15\text{ A}, R_G = 2.5\ \Omega, V_{GE} = 15\text{ V}, \text{Inductive Load}$	$t_{d(on)}$	-	18	-	ns	
Rise Time		$t_r$	-	13	-		
Turn-off Delay Time		$t_{d(off)}$	-	68	-		
Fall Time			$t_f$	-	104	-	
Turn-on Switching Loss			$E_{on}$	-	0.34	-	mJ
Turn-off Switching Loss			$E_{off}$	-	0.32	-	
Total Switching Loss			$E_{ts}$	-	0.65	-	
Turn-on Delay Time	$T_J = 25^\circ\text{C}, V_{CC} = 400\text{ V}, I_C = 30\text{ A}, R_G = 2.5\ \Omega, V_{GE} = 15\text{ V}, \text{Inductive Load}$	$t_{d(on)}$	-	19	-	ns	
Rise Time		$t_r$	-	29	-		
Turn-off Delay Time		$t_{d(off)}$	-	61	-		
Fall Time			$t_f$	-	78	-	
Turn-on Switching Loss			$E_{on}$	-	0.79	-	mJ
Turn-off Switching Loss			$E_{off}$	-	0.54	-	
Total Switching Loss			$E_{ts}$	-	1.30	-	

# AFGHL30T65RQDN

## ELECTRICAL CHARACTERISTICS ( $T_J = 25^\circ\text{C}$ unless otherwise noted) (Continued)

Parameter	Test Conditions	Symbol	Min	Typ	Max	Unit
-----------	-----------------	--------	-----	-----	-----	------

### SWITCHING CHARACTERISTICS, INDUCTIVE LOAD

Turn-on Delay Time	$T_J = 175^\circ\text{C}$ , $V_{CC} = 400\text{ V}$ , $I_C = 15\text{ A}$ , $R_G = 2.5\ \Omega$ , $V_{GE} = 15\text{ V}$ , Inductive Load	$t_{d(on)}$	-	18	-	ns
Rise Time		$t_r$	-	17	-	
Turn-off Delay Time		$t_{d(off)}$	-	83	-	
Fall Time		$t_f$	-	196	-	
Turn-on Switching Loss		$E_{on}$	-	0.53	-	mJ
Turn-off Switching Loss		$E_{off}$	-	0.69	-	
Total Switching Loss		$E_{ts}$	-	1.22	-	
Turn-on Delay Time	$T_J = 175^\circ\text{C}$ , $V_{CC} = 400\text{ V}$ , $I_C = 30\text{ A}$ , $R_G = 2.5\ \Omega$ , $V_{GE} = 15\text{ V}$ , Inductive Load	$t_{d(on)}$	-	21	-	ns
Rise Time		$t_r$	-	37	-	
Turn-off Delay Time		$t_{d(off)}$	-	72	-	
Fall Time		$t_f$	-	164	-	
Turn-on Switching Loss		$E_{on}$	-	1.14	-	mJ
Turn-off Switching Loss		$E_{off}$	-	1.09	-	
Total Switching Loss		$E_{ts}$	-	2.23	-	

### DIODE CHARACTERISTICS

Diode Forward Voltage	$I_F = 30\text{ A}$ , $T_J = 25^\circ\text{C}$	$V_F$	-	1.7	2.10	V
	$I_F = 30\text{ A}$ , $T_J = 175^\circ\text{C}$		-	1.74	-	

### DIODE SWITCHING CHARACTERISTICS, INDUCTIVE LOAD

Reverse Recovery Energy	$I_F = 30\text{ A}$ , $di_F/dt = 1000\text{ A}/\mu\text{s}$ , $V_R = 400\text{ V}$ , $T_J = 25^\circ\text{C}$	$E_{rec}$	-	46	-	$\mu\text{J}$
Diode Reverse Recovery Time		$T_{rr}$	-	39	-	nS
Diode Reverse Recovery Charge		$Q_{rr}$	-	345	-	nC
Reverse Recovery Energy	$I_F = 30\text{ A}$ , $di_F/dt = 1000\text{ A}/\mu\text{s}$ , $V_R = 400\text{ V}$ , $T_J = 175^\circ\text{C}$	$E_{rec}$	-	205	-	$\mu\text{J}$
Diode Reverse Recovery Time		$T_{rr}$	-	85	-	nS
Diode Reverse Recovery Charge		$Q_{rr}$	-	1002	-	nC

Product parametric performance is indicated in the Electrical Characteristics for the listed test conditions, unless otherwise noted. Product performance may not be indicated by the Electrical Characteristics if operated under different conditions.

# AFGHL30T65RQDN

## TYPICAL CHARACTERISTICS

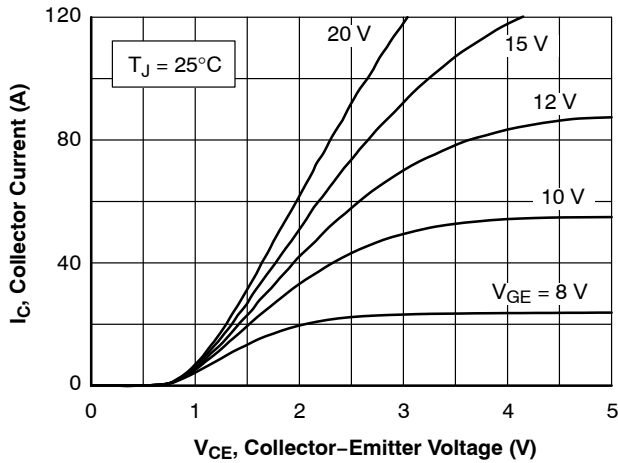

Figure 1. Typical Output Characteristics

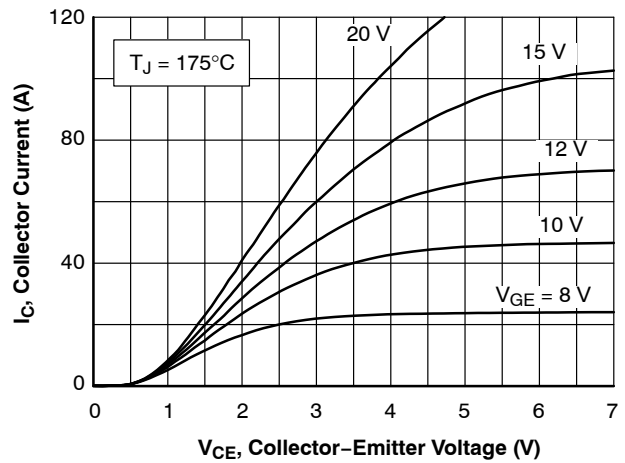

Figure 2. Typical Output Characteristics

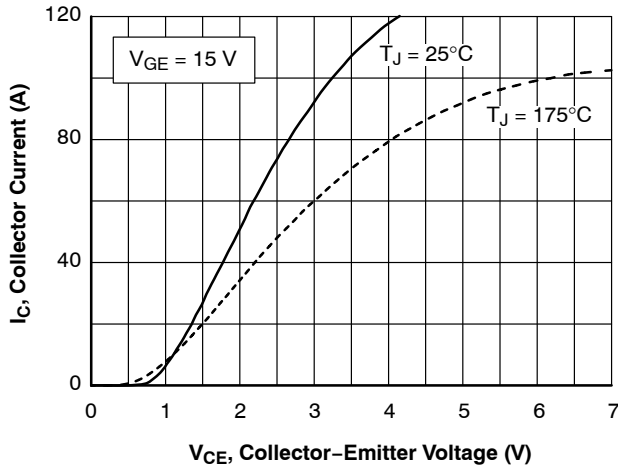

Figure 3. Typical Saturation Voltage Characteristics

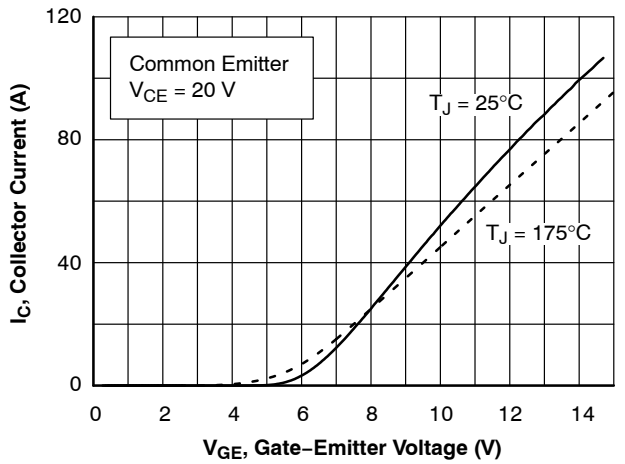

Figure 4. Typical Transfer Characteristics

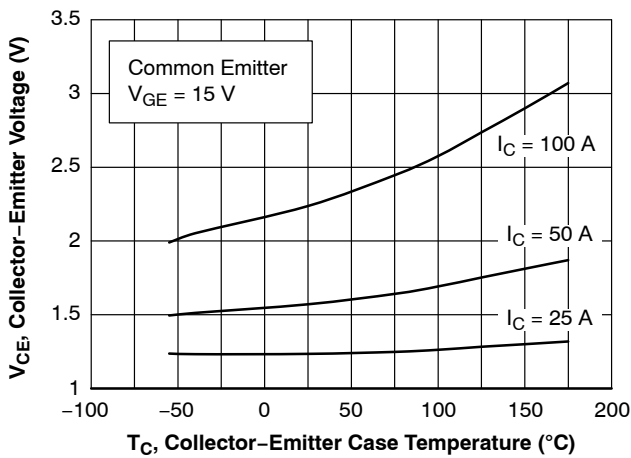

Figure 5. Saturation Voltage vs. Case Temperature at Variant Current Level

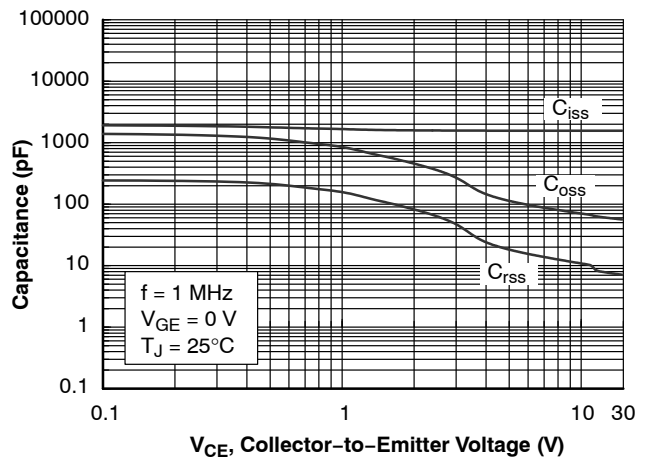

Figure 6. Capacitance Characteristics

# AFGHL30T65RQDN

## TYPICAL CHARACTERISTICS (Continued)

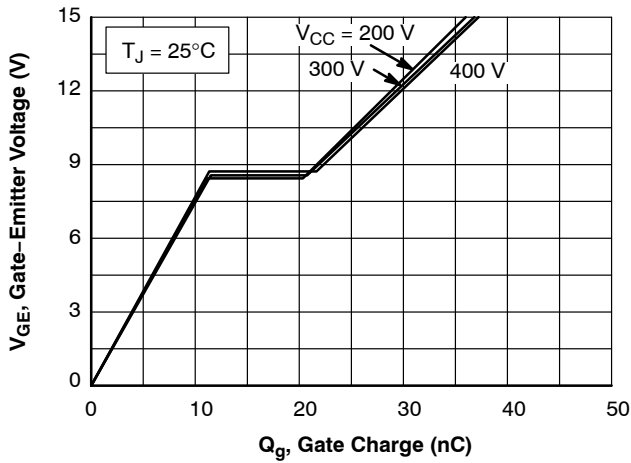

Figure 7. Gate Charge Characteristics

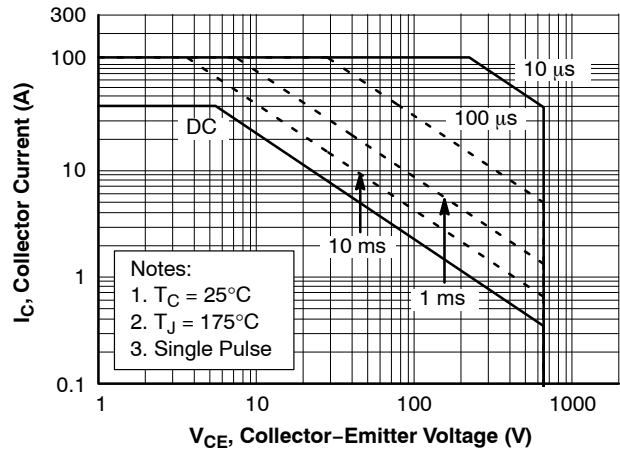

Figure 8. SOA Characteristics

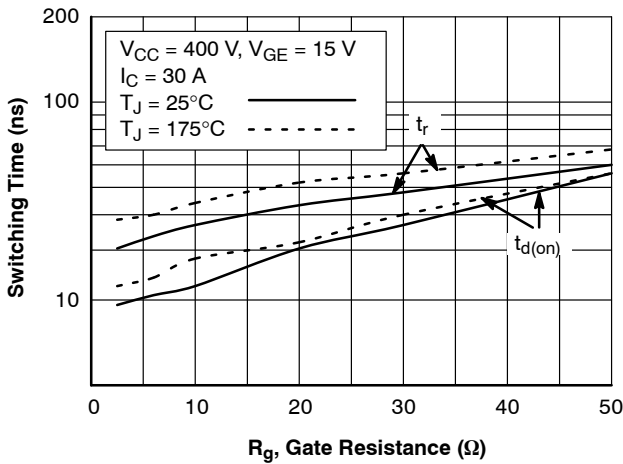

Figure 9. Turn-on Characteristics vs. Gate Resistance

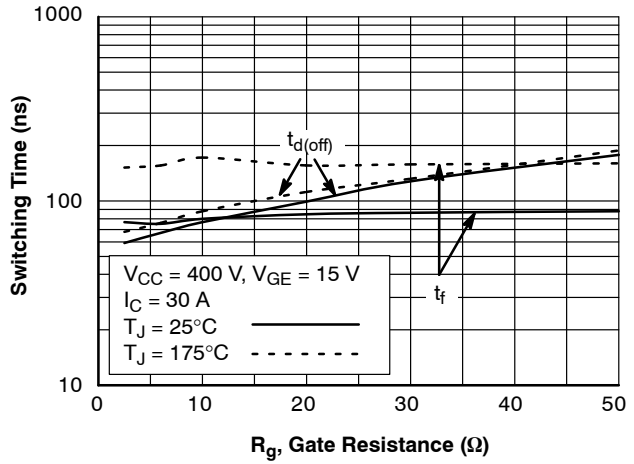

Figure 10. Turn-off Characteristics vs. Gate Resistance

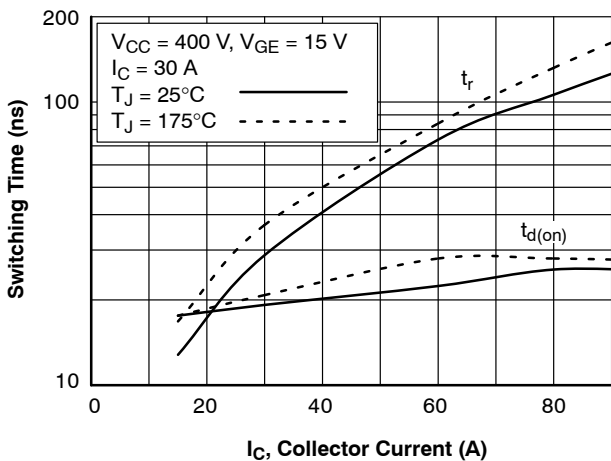

Figure 11. Turn-on Characteristics vs. Collector Current

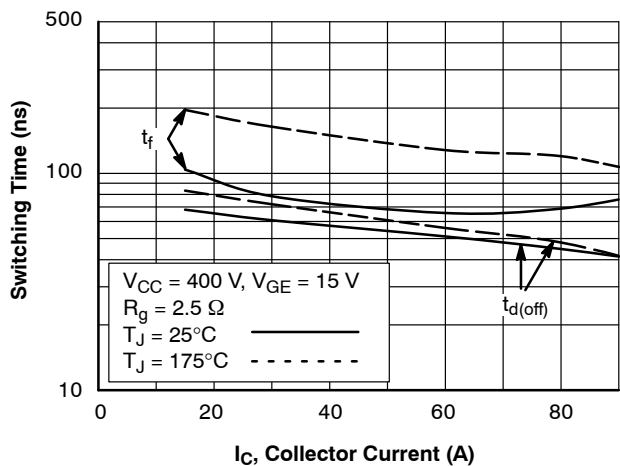

Figure 12. Turn-off Characteristics vs. Collector Current

# AFGHL30T65RQDN

## TYPICAL CHARACTERISTICS (Continued)

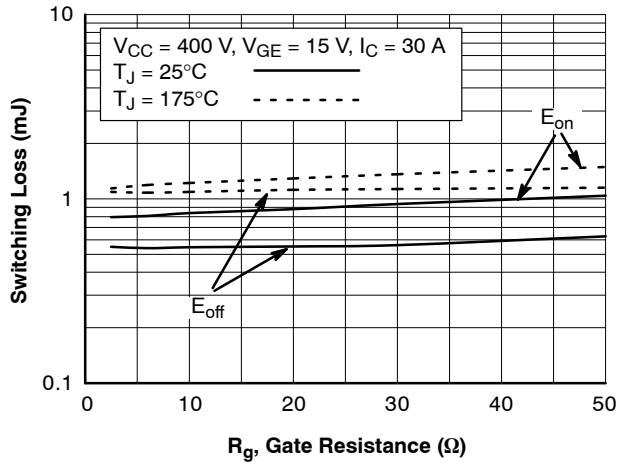

Figure 13. Switching Loss vs. Gate Resistance

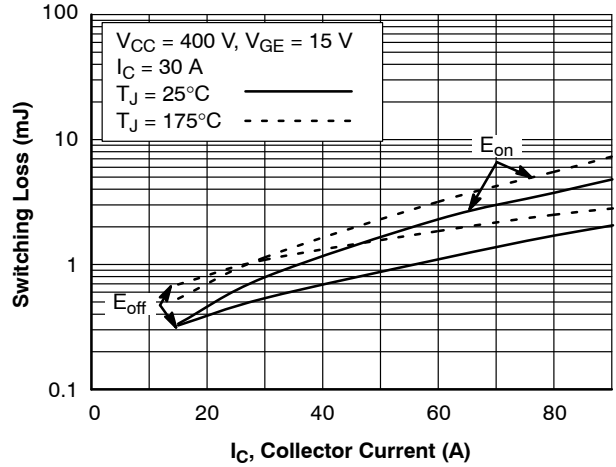

Figure 14. Switching Loss vs. Collector Current

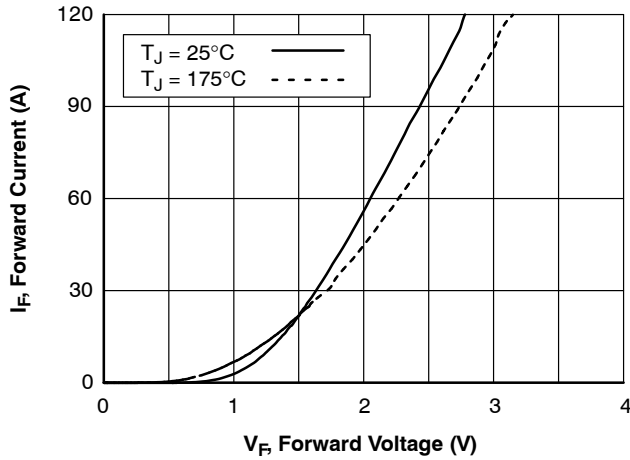

Figure 15. Forward Characteristics

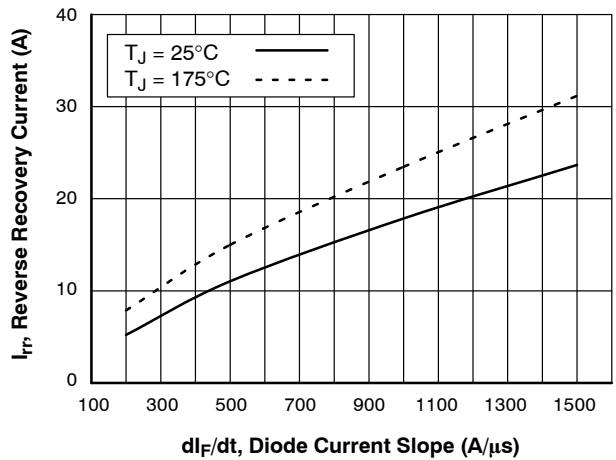

Figure 16. Reverse Recovery Current

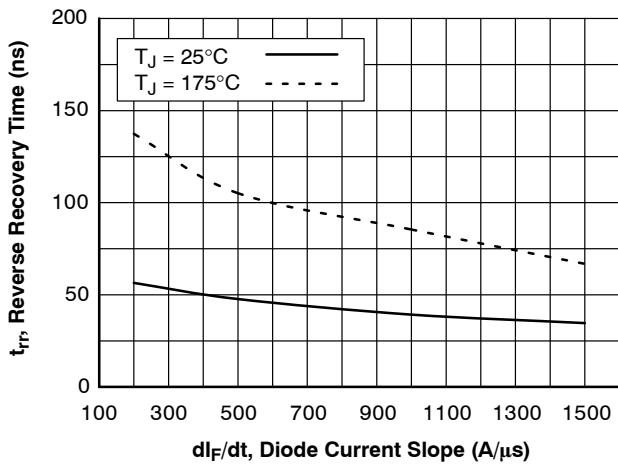

Figure 17. Reverse Recovery Time

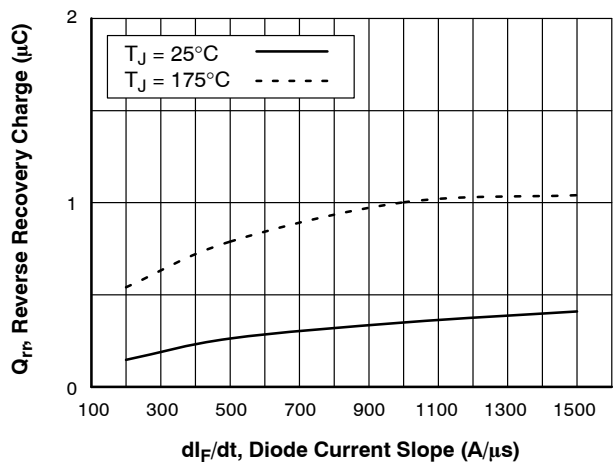

Figure 18. Stored Charge

# AFGHL30T65RQDN

## TYPICAL CHARACTERISTICS (Continued)

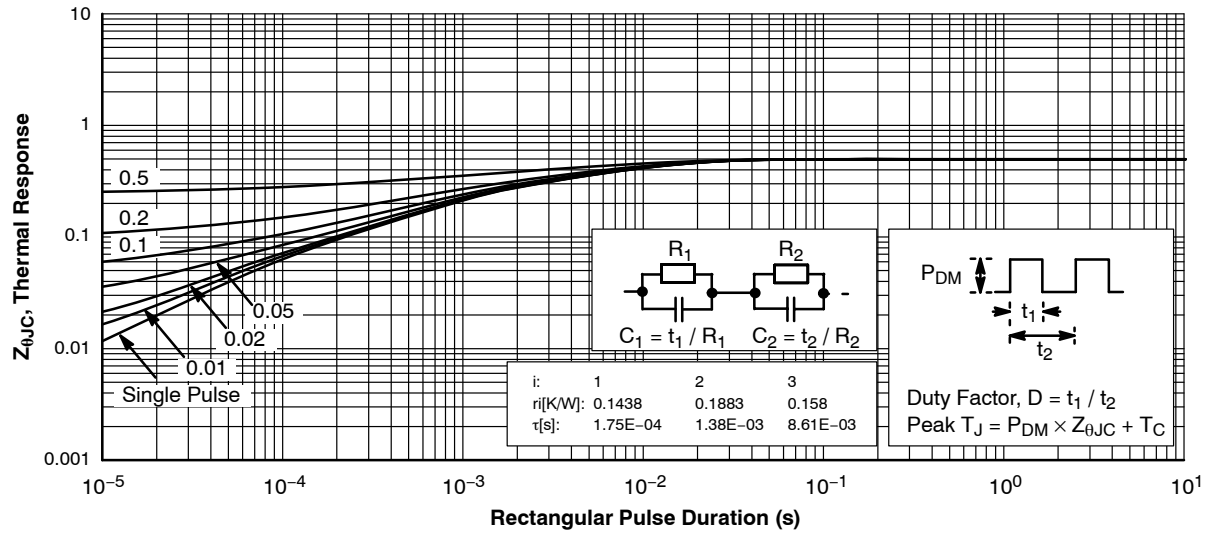

Figure 19. Transient Thermal Impedance of IGBT

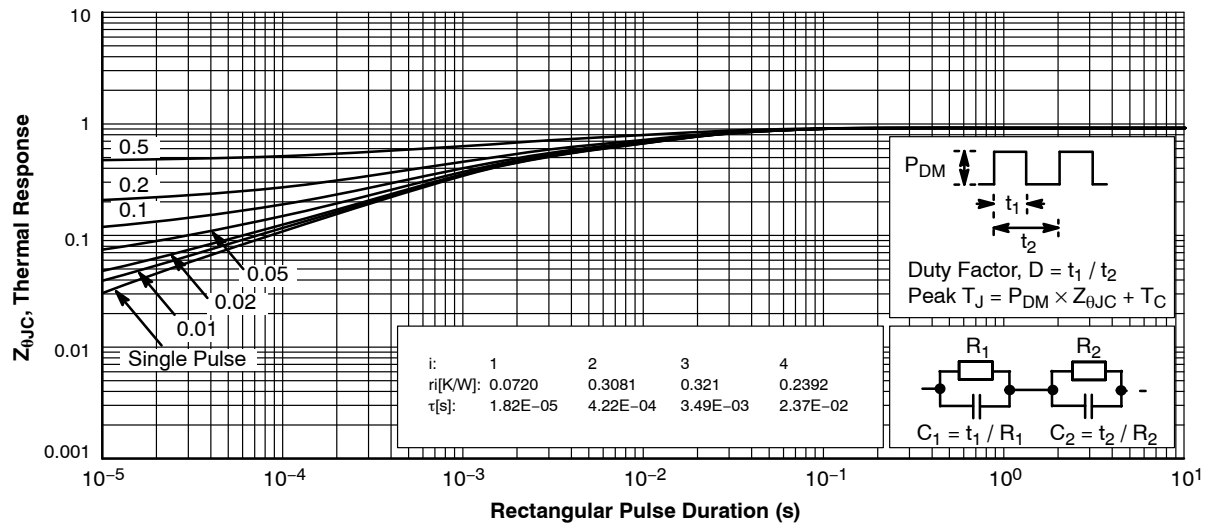
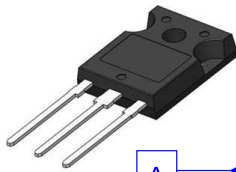
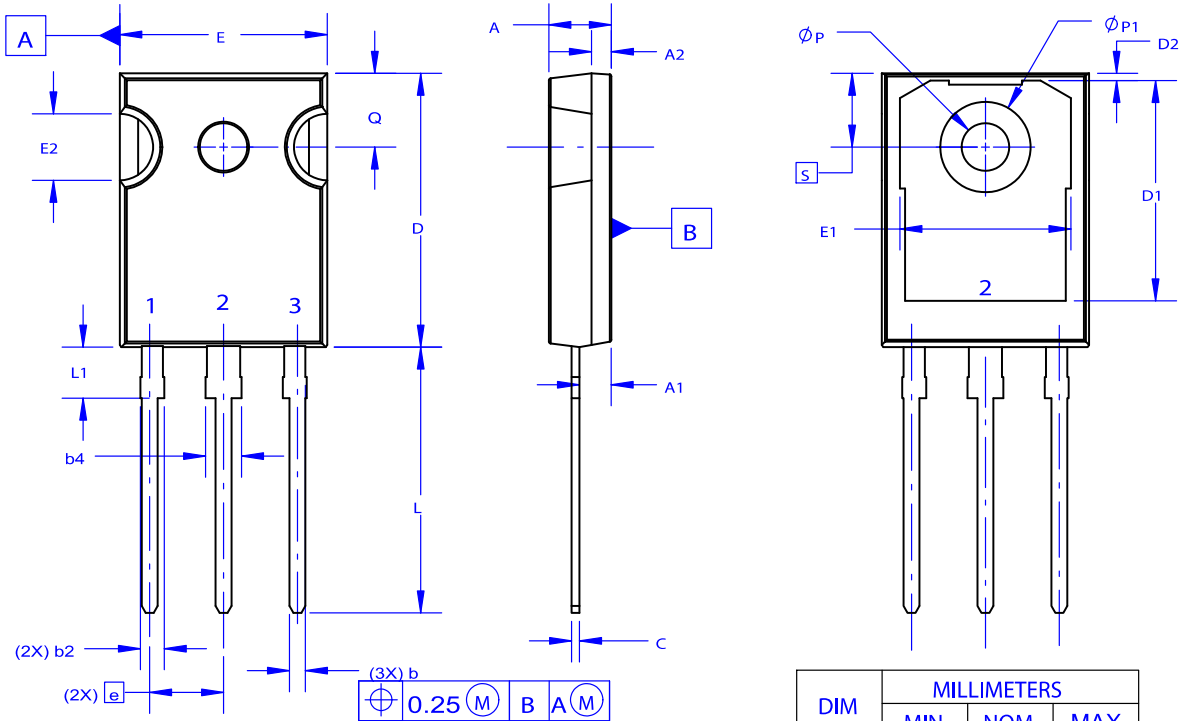

Figure 20. Transient Thermal Impedance of Diode



TO-247-3LD  
CASE 340CX  
ISSUE A

DATE 06 JUL 2020



NOTES: UNLESS OTHERWISE SPECIFIED.

- A. DIMENSIONS ARE EXCLUSIVE OF BURRS, MOLD FLASH, AND TIE BAR EXTRUSIONS.
- B. ALL DIMENSIONS ARE IN MILLIMETERS.
- C. DRAWING CONFORMS TO ASME Y14.5 - 2009.
- D. DIMENSION A1 TO BE MEASURED IN THE REGION DEFINED BY L1.
- E. LEAD FINISH IS UNCONTROLLED IN THE REGION DEFINED BY L1.

GENERIC MARKING DIAGRAM\*



- XXXXX = Specific Device Code
- A = Assembly Location
- Y = Year
- WW = Work Week
- G = Pb-Free Package

\*This information is generic. Please refer to device data sheet for actual part marking. Pb-Free indicator, "G" or microdot "▪", may or may not be present. Some products may not follow the Generic Marking.

DIM	MILLIMETERS		
	MIN	NOM	MAX
A	4.58	4.70	4.82
A1	2.20	2.40	2.60
A2	1.40	1.50	1.60
D	20.32	20.57	20.82
E	15.37	15.62	15.87
E2	4.96	5.08	5.20
e	~	5.56	~
L	19.75	20.00	20.25
L1	3.69	3.81	3.93
ØP	3.51	3.58	3.65
Q	5.34	5.46	5.58
S	5.34	5.46	5.58
b	1.17	1.26	1.35
b2	1.53	1.65	1.77
b4	2.42	2.54	2.66
c	0.51	0.61	0.71
D1	13.08	~	~
D2	0.51	0.93	1.35
E1	12.81	~	~
ØP1	6.60	6.80	7.00

DOCUMENT NUMBER:	98AON93302G	Electronic versions are uncontrolled except when accessed directly from the Document Repository. Printed versions are uncontrolled except when stamped "CONTROLLED COPY" in red.
DESCRIPTION:	TO-247-3LD	PAGE 1 OF 1

onsemi and Onsemi are trademarks of Semiconductor Components Industries, LLC dba onsemi or its subsidiaries in the United States and/or other countries. onsemi reserves the right to make changes without further notice to any products herein. onsemi makes no warranty, representation or guarantee regarding the suitability of its products for any particular purpose, nor does onsemi assume any liability arising out of the application or use of any product or circuit, and specifically disclaims any and all liability, including without limitation special, consequential or incidental damages. onsemi does not convey any license under its patent rights nor the rights of others.

**onsemi**, **Onsemi**, and other names, marks, and brands are registered and/or common law trademarks of Semiconductor Components Industries, LLC dba "**onsemi**" or its affiliates and/or subsidiaries in the United States and/or other countries. **onsemi** owns the rights to a number of patents, trademarks, copyrights, trade secrets, and other intellectual property. A listing of **onsemi**'s product/patent coverage may be accessed at [www.onsemi.com/site/pdf/Patent-Marking.pdf](http://www.onsemi.com/site/pdf/Patent-Marking.pdf). **onsemi** reserves the right to make changes at any time to any products or information herein, without notice. The information herein is provided "as-is" and **onsemi** makes no warranty, representation or guarantee regarding the accuracy of the information, product features, availability, functionality, or suitability of its products for any particular purpose, nor does **onsemi** assume any liability arising out of the application or use of any product or circuit, and specifically disclaims any and all liability, including without limitation special, consequential or incidental damages. Buyer is responsible for its products and applications using **onsemi** products, including compliance with all laws, regulations and safety requirements or standards, regardless of any support or applications information provided by **onsemi**. "Typical" parameters which may be provided in **onsemi** data sheets and/or specifications can and do vary in different applications and actual performance may vary over time. All operating parameters, including "Typicals" must be validated for each customer application by customer's technical experts. **onsemi** does not convey any license under any of its intellectual property rights nor the rights of others. **onsemi** products are not designed, intended, or authorized for use as a critical component in life support systems or any FDA Class 3 medical devices or medical devices with a same or similar classification in a foreign jurisdiction or any devices intended for implantation in the human body. Should Buyer purchase or use **onsemi** products for any such unintended or unauthorized application, Buyer shall indemnify and hold **onsemi** and its officers, employees, subsidiaries, affiliates, and distributors harmless against all claims, costs, damages, and expenses, and reasonable attorney fees arising out of, directly or indirectly, any claim of personal injury or death associated with such unintended or unauthorized use, even if such claim alleges that **onsemi** was negligent regarding the design or manufacture of the part. **onsemi** is an Equal Opportunity/Affirmative Action Employer. This literature is subject to all applicable copyright laws and is not for resale in any manner.

## ADDITIONAL INFORMATION

### TECHNICAL PUBLICATIONS:

Technical Library: [www.onsemi.com/design/resources/technical-documentation](http://www.onsemi.com/design/resources/technical-documentation)  
onsemi Website: [www.onsemi.com](http://www.onsemi.com)

### ONLINE SUPPORT: [www.onsemi.com/support](http://www.onsemi.com/support)

For additional information, please contact your local Sales Representative at [www.onsemi.com/support/sales](http://www.onsemi.com/support/sales)

